



Wireless Dry Contact Sensors

General Description

ioX wireless dry contact sensors can be used to detect contact between two wired contact points, an external mechanical switch or a contact plate.

- 1 ft. (12 inch) lead wires
- Can integrate with switches

Principle of Operation

The ioX wireless dry contact sensor detects when there is contact between the two wired end points. It can easily be integrated into existing switches or contact plates. When the sensor detects contact between the two end points, it will immediately turn on the RF radio and transmit the data to the wireless gateway and ioX-Connect Online Sensor Monitoring and Notification System, allowing the user to immediately receive an SMS text or email alert. The sensor can be configured to detect both closed and open loops alerting if contact is made or broken.

Example Applications

- Barn door monitoring
- Freezer / cooler door monitoring
- Forklift seat switches
- Button or switch integration
- Production line tracking

Features of ioX-Connect Sensors

- Wireless range of 1,000+ feet through 12-14 walls *
- Frequency Hopping Spread Spectrum (FHSS)
- Improved interference immunity
- Improved power management for longer battery life ** (10+ years on AA batteries)
- Security (Diffie-Hellman Key Exchange + AES-128 CBC for sensor data messages)
- Onboard data memory / storage (up to 512 readings per sensor)
 - 10 min heartbeats = 3.5 days
 - 2 hour heartbeats = 42 days
- Over-the-air updates (future proof)
- Free ioX-Basic online wireless sensor monitoring and notification system to configure sensors, view data and set alerts via SMS text and email.

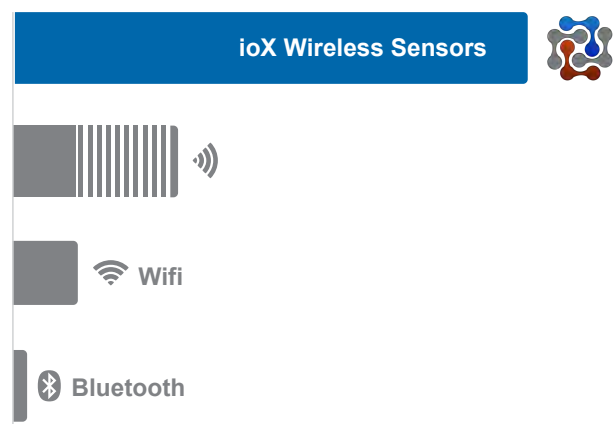

* Actual range may vary depending on environment. ** Battery life is determined by sensor reporting frequency and other variables. Other power options are also available.

Wireless Range Comparison

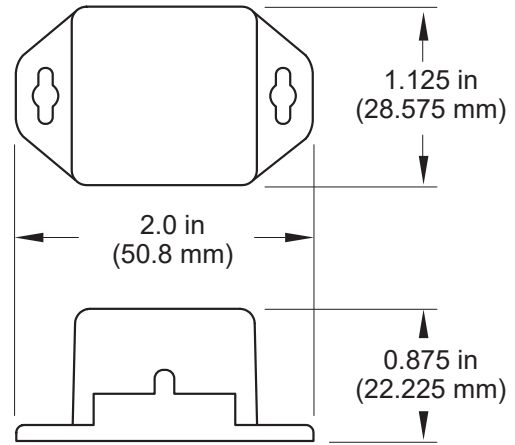



ioX Commercial Coin Cell Wireless Dry Contact Sensor - Technical Specifications

Supply Voltage	2.0 - 3.8 VDC *
Current Consumption	0.2 μ A (Sleep Mode) 0.7 μ A (RTC Sleep) 570 μ A (MCU Idle) 2.5 mA (MCU Active) 5.5 mA (Radio RX Mode) 22.6 mA (Radio TX Mode)
Operating Temperature Range (Board Circuitry and Coin Cell)	-7°C to +60°C (20°F to +140°F) **
Optimal Battery Temperature Range (Coin Cell)	+10°C to +50°C (+50°F to +122°F)
Lead Wire Length	1 ft. (12 in.)
Detection Wires	High Impedance
Integrated Memory	Up to 512 sensor messages
Wireless Range	1,000+ ft. non-line-of-sight
Security	256-bit key exchange and AES-128 CTR
Weight	0.7 Ounces
Certifications	   Industry Canada 900 MHz product; FCC ID: ZTL- G2SC1 and IC: 9794A-G2SC1. 868 and 433 MHz product tested and found to comply with: EN 300 220-2 V3.1.1 (2017-02), EN 300 220-2 V3.1.1 (2017-02) and EN 60950.

* Hardware cannot withstand negative voltage. Please take care when connecting a power device.

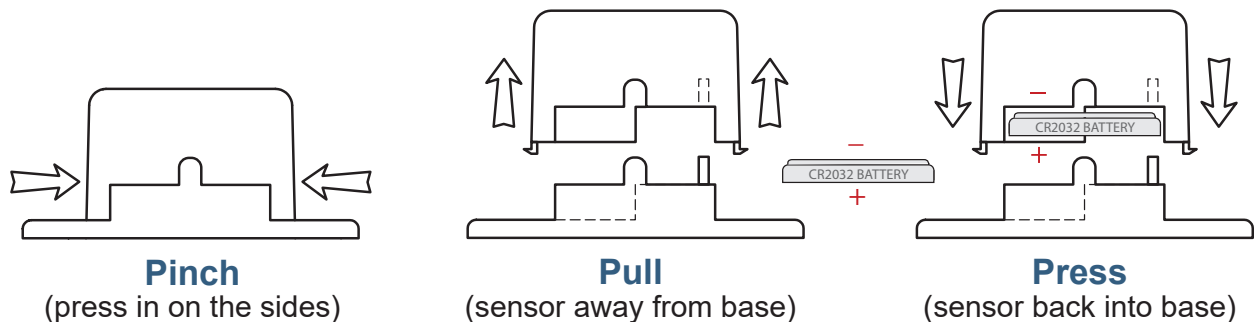

** At temperatures above 100°C, it is possible for the board circuitry to lose programmed memory.

Upgraded Coin Cell Enclosures





ioX Commercial AA Wireless Dry Contact Sensor - Technical Specifications

Supply Voltage	2.0 - 3.8 VDC (3.0 - 3.8 VDC Using Power Supply) *
Current Consumption	0.2 μ A (Sleep Mode) 0.7 μ A (RTC Sleep) 570 μ A (MCU Idle) 2.5 mA (MCU Active) 5.5 mA (Radio RX Mode) 22.6 mA (Radio TX Mode)
Operating Temperature Range (Board Circuitry and Batteries)	-18°C to 55°C (0°F to 130°F) using alkaline -40°C to 85°C (-40°F to 185°F) using lithium **
Optimal Battery Temperature Range (AA)	+10°C to +50°C (+50°F to +122°F)
Lead Wire Length	1 ft. (12 in.)
Detection Wires	High Impedance
Integrated Memory	Up to 512 sensor messages
Wireless Range	1,000+ ft. non-line-of-sight
Security	256-bit key exchange and AES-128 CTR
Weight	3.7 Ounces
Certifications	<div style="display: flex; align-items: center; gap: 10px;">    Industry Canada </div> 900 MHz product; FCC ID: ZTL- G2SC1 and IC: 9794A-G2SC1. 868 and 433 MHz product tested and found to comply with: EN 300 220-2 V3.1.1 (2017-02), EN 300 220-2 V3.1.1 (2017-02) and EN 60950.

* Hardware cannot withstand negative voltage. Please take care when connecting a power device.

** At temperatures above 100°C, it is possible for the board circuitry to lose programmed memory.

Power Options



The standard version of this sensor is powered by two replaceable 1.5 V AA sized batteries (included with purchase).

This sensor is also available with a line power option. The line powered version of this sensor has a barrel power connector allowing it to be powered by a standard 3.0 - 3.6 V power supply. The line powered version also uses two standard 1.5 V AA batteries as backup for un-interrupted operation in the event of line power outage.

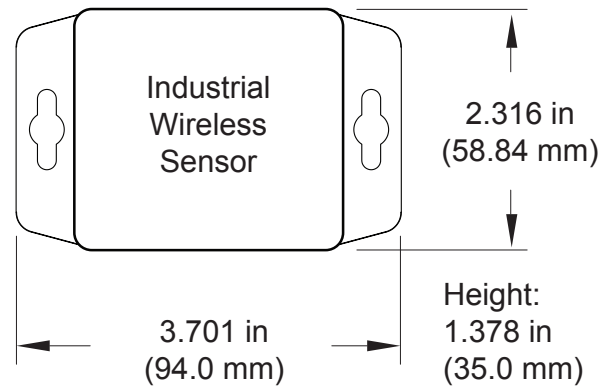
Power options must be selected at time of purchase, as the internal hardware of the sensor must be changed to support the selected power requirements.



ioX Industrial Wireless Dry Contact Sensor - Technical Specifications

Supply Voltage	2.0 - 3.8 VDC (3.0 - 3.8 VDC Using Power Supply) *	
Current Consumption	0.2 μ A (Sleep Mode) 0.7 μ A (RTC Sleep) 570 μ A (MCU Idle) 2.5 mA (MCU Active) 5.5 mA (Radio RX Mode) 22.6 mA (Radio TX Mode)	
Operating Temperature Range (Board Circuitry and Battery)	-40°C to +85°C (-40°F to +185°F) **	
Included Battery	Max Temperature Range:	-40°C to +85°C (-40°F to +185°F)
	Capacity:	1800 mAh
Optional Solar Feature	Solar Panel:	5VDC / 30mA (53mm x 30mm)
	Charging Temperature Range:	0°C to 45°C (32°F to 113°F)
	Max Temperature Range:	-20°C to 60°C (-4°F to 140°F)
	Included Rechargeable Battery:	600 mAh / >2000 Charge Cycles (80% of initial capacity)
Lead Wire Length	1 ft. (12 in.)	
Detection Wires	High Impedance	
Integrated Memory	Up to 512 sensor messages	
Wireless Range	1,000+ ft. non-line-of-sight	
Security	256-bit key exchange and AES-128 CTR	
Weight	4.7 Ounces	
Enclosure Rating	NEMA 1, 2, 4, 4x, 12 and 13 rated, sealed and weather proof	
UL Rating	UL Listed to UL508-4x specifications (File E194432)	
Certifications	   Industry Canada	900 MHz product; FCC ID: ZTL- G2SC1 and IC: 9794A-G2SC1. 868 and 433 MHz product tested and found to comply with: EN 300 220-2 V3.1.1 (2017-02), EN 300 220-2 V3.1.1 (2017-02) and EN 60950.

* Hardware cannot withstand negative voltage. Please take care when connecting a power device.

** At temperatures above 100°C, it is possible for the board circuitry to lose programmed memory.

Commercial Grade Sensors:

Commercial grade sensors are designed for applications in ordinary environments (normal room temperature, humidity and atmospheric pressure). Do not use these sensors under the following conditions as these factors can deteriorate the product characteristics and cause failures and burn-out.

- Corrosive gas or deoxidizing gas - chlorine gas, hydrogen sulfide gas, ammonia gas, sulfuric acid gas, nitric oxides gas, etc.)
- Volatile or flammable gas
- Dusty conditions
- Under low or high pressure
- Wet or excessively humid locations
- Places with salt water, oils chemical liquids or organic solvents
- Where there are excessively strong vibrations
- Other places where similar hazardous conditions exist

Use these product within the specified temperature range. Higher temperature may cause deterioration of the characteristics or the material quality.

Industrial Grade Sensors - Type 1, 2, 4, 4X, 12 and 13 NEMA Rated Enclosure:

ioX's Industrial sensors are enclosed in reliable, weatherproof NEMA rated enclosures. The NEMA rated enclosures are constructed for both indoor or outdoor use and protect the sensor circuitry against the ingress of solid foreign objects like dust as well as the damaging effects of water (rain, sleet, snow, splashing water, and hose directed water).

- Safe from falling dirt
- Protects against wind blown dust
- Protects against rain, sleet, snow, splashing water, and hose directed water
- Increased level of corrosion resistance
- Will remain undamaged by ice formation on the enclosure



ioX-Connect is an EAMS
Global-USA Inc. brand.

For more information about our products or to place an order,
please contact our sales department at sales@eams-usa.com

Visit us on the web at www.eams-global.com

382NE 191st Street,
Miami, FL 78414
407-287-5928